

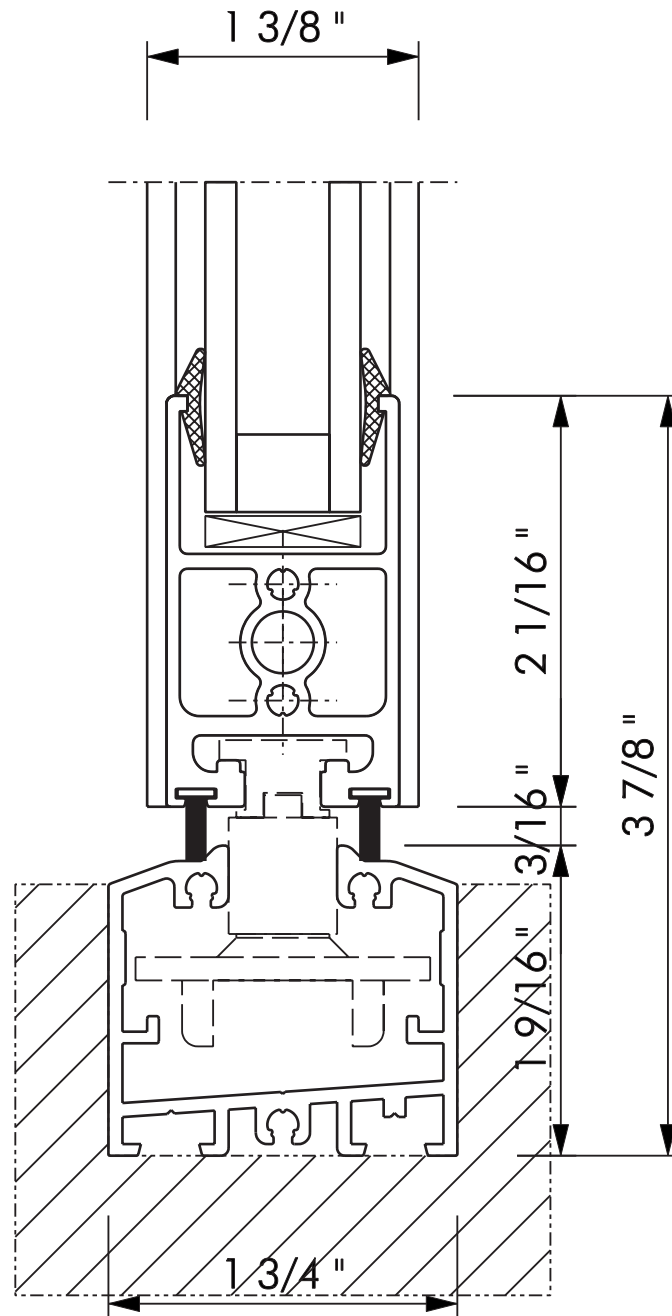

OUTSIDE



INSIDE

Description: **Vertical-Section,
flush bottom track**

System: **SF35**

Detail-No.: **SF35-004**