

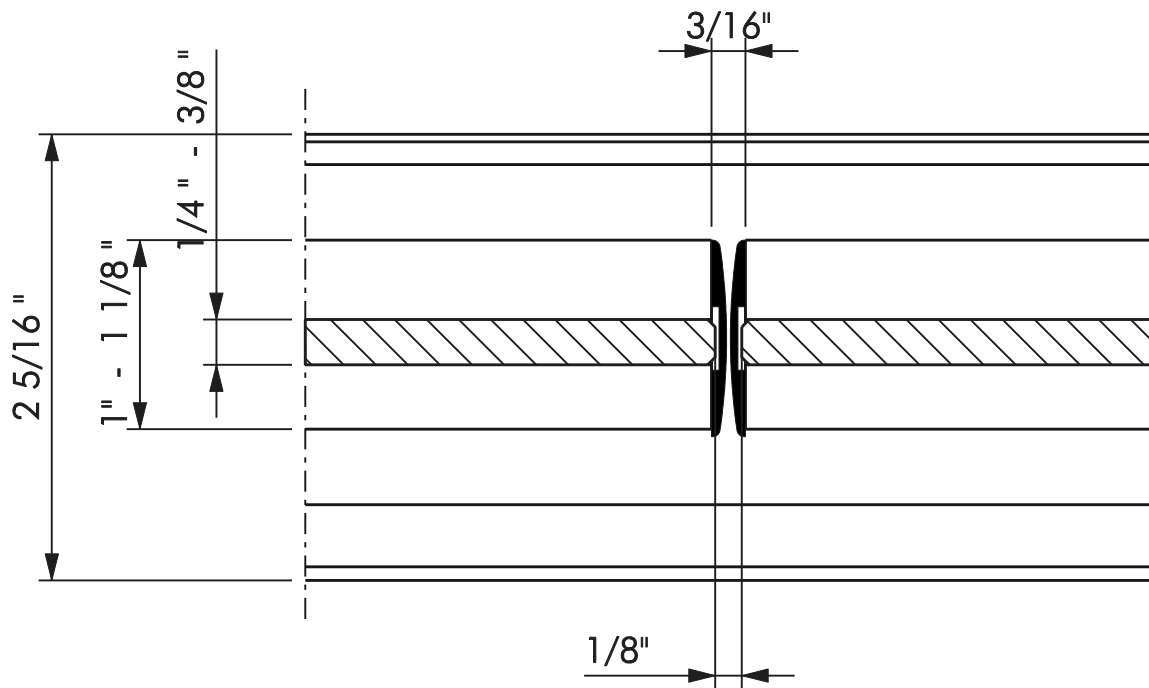

OUTSIDE



INSIDE

Description: **Horizontal-Section,
panel - panel**

System: **SF25**

Detail-No.: **SF25-102**